

Leave
blank

Handwriting practice area consisting of 25 horizontal lines.

Q1

(Total 4 marks)



Candidates are reminded they must complete their answers in blue or black ink or pencil.

2.

Figure 1

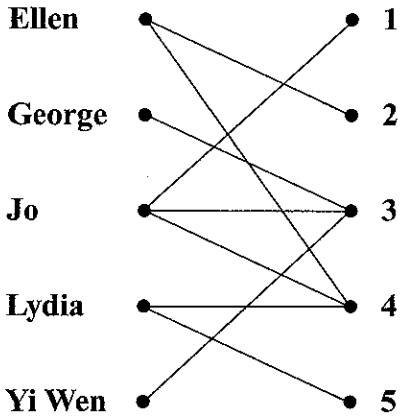
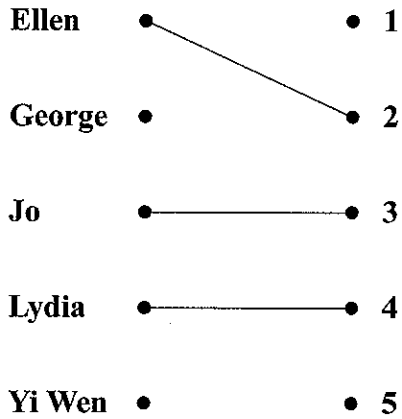

Figure 2



Handwriting practice lines consisting of multiple horizontal dashed lines.

(Total 7 marks)

Q2

Small empty box for marking.



4.

Basic variable	x	y	z	r	s	Value
r	2	0	4	1	0	80
s	1	4	2	0	1	160
P	-2	-8	-20	0	0	0

You may not need to use all of these tableaux

Basic variable	x	y	z	r	s	Value	Row operations

Basic variable	x	y	z	r	s	Value	Row operations

Basic variable	x	y	z	r	s	Value	Row operations

.....

.....

.....

.....

.....

.....

.....

.....

.....

.....

.....

.....

(Total 7 marks)

Q4



Leave blank

5. _____

Q5

(Total 7 marks)

7



6.

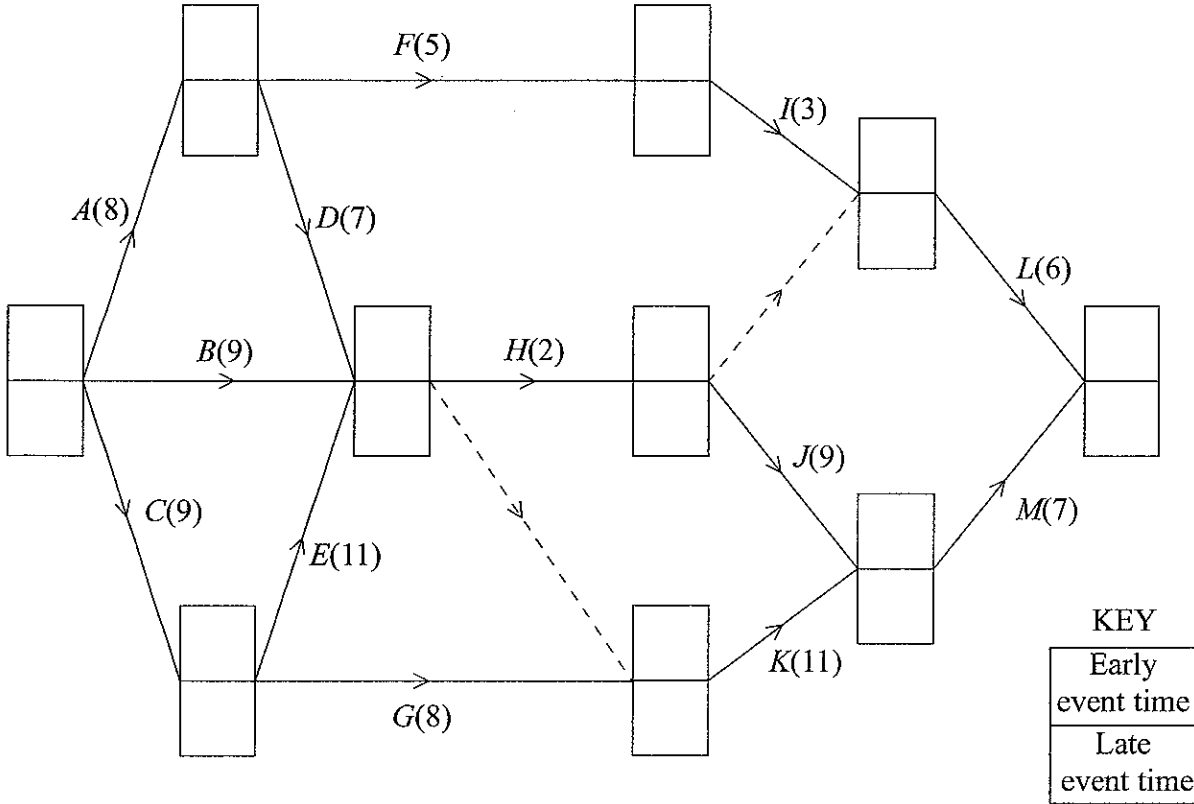

Leave blank

Ruled area for writing answers.

0 2 4 6 8 10 12 14 16 18 20 22 24 26 28 30 32 34 36 38 40

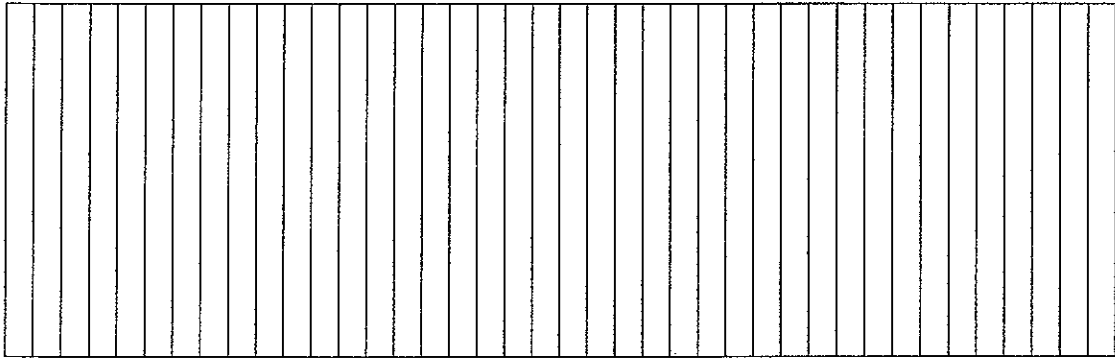

(Total 16 marks)

Q6

--	--



Leave blank

7.



Diagram 1

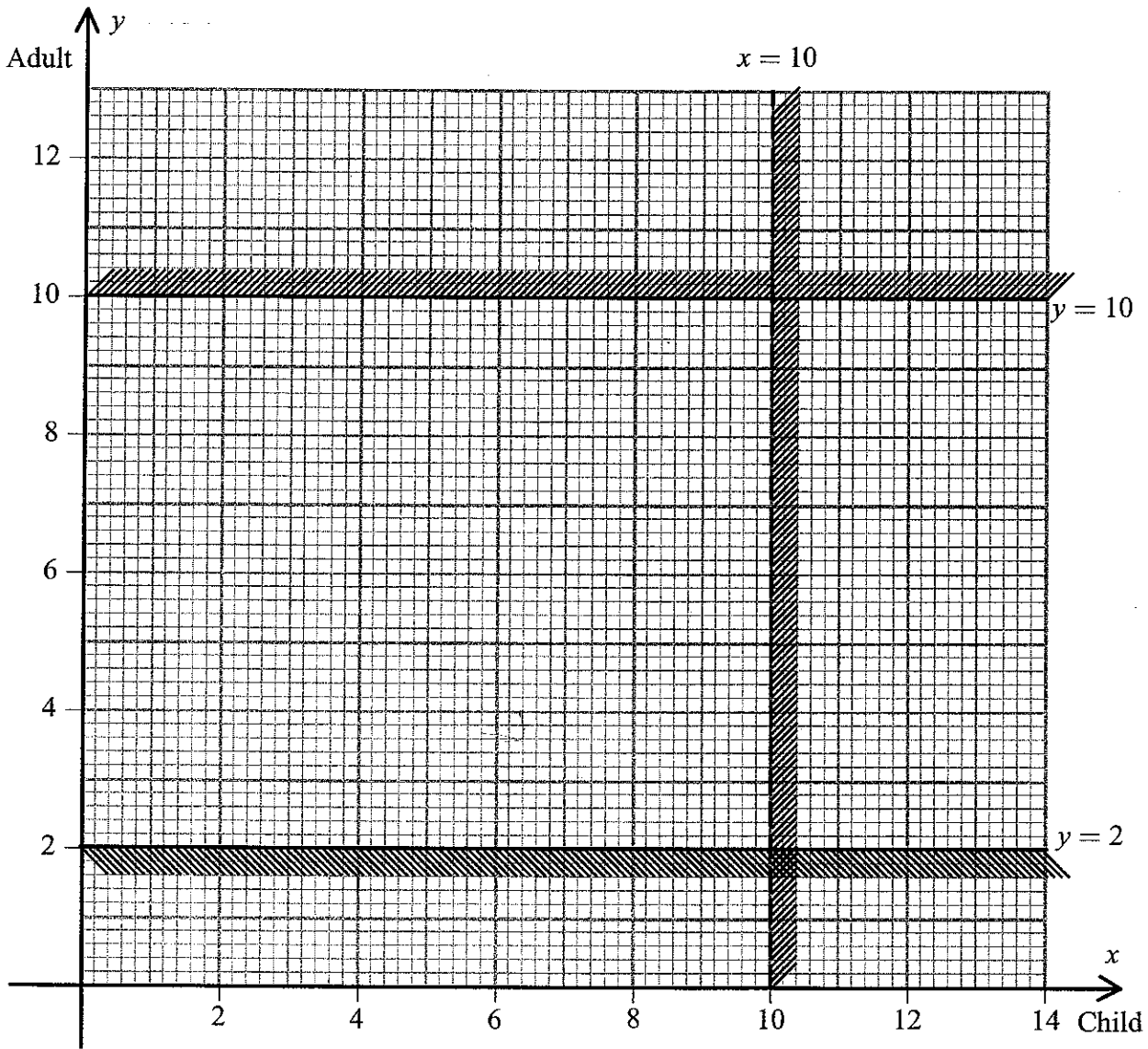

(Total 14 marks)

Q7

--	--



Diagram 2

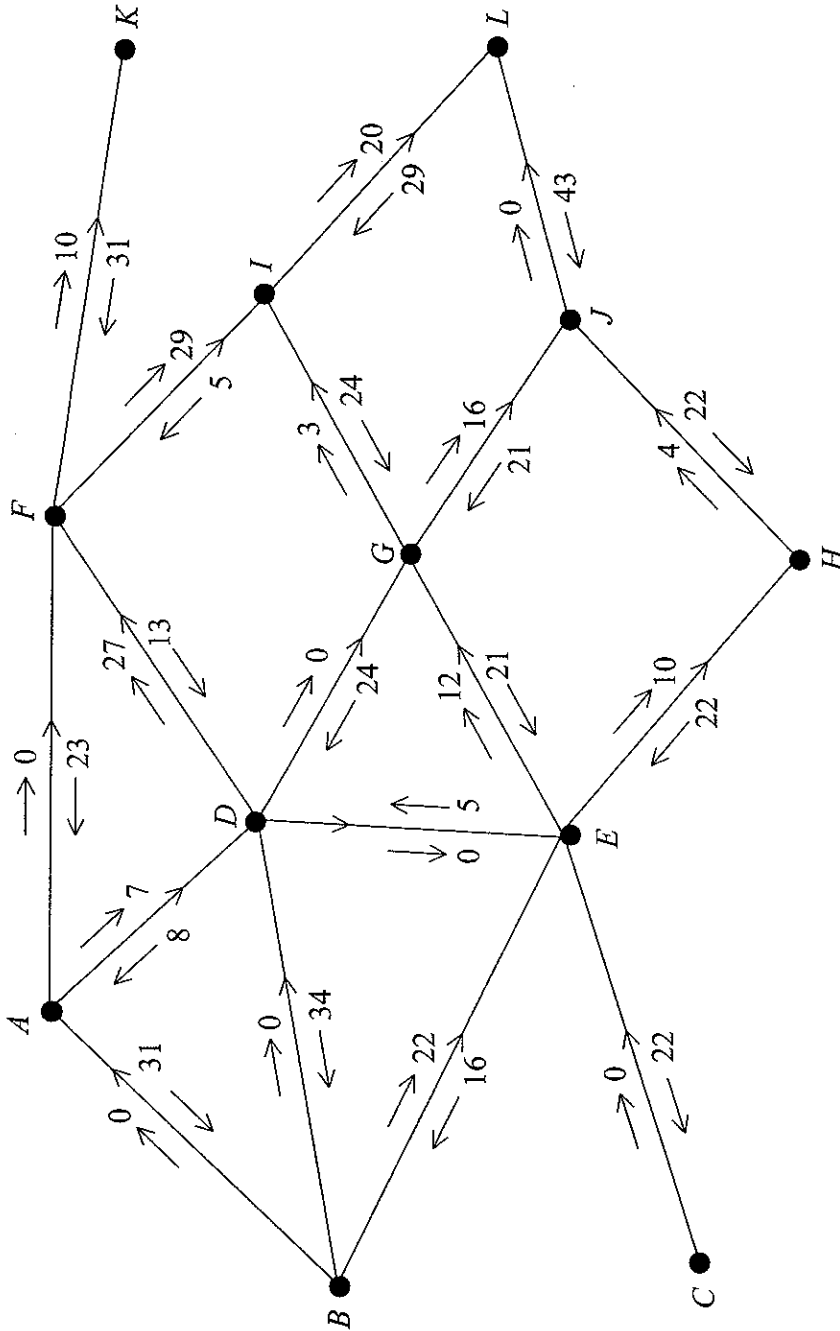

8.

Value of initial flow _____



Diagram 3

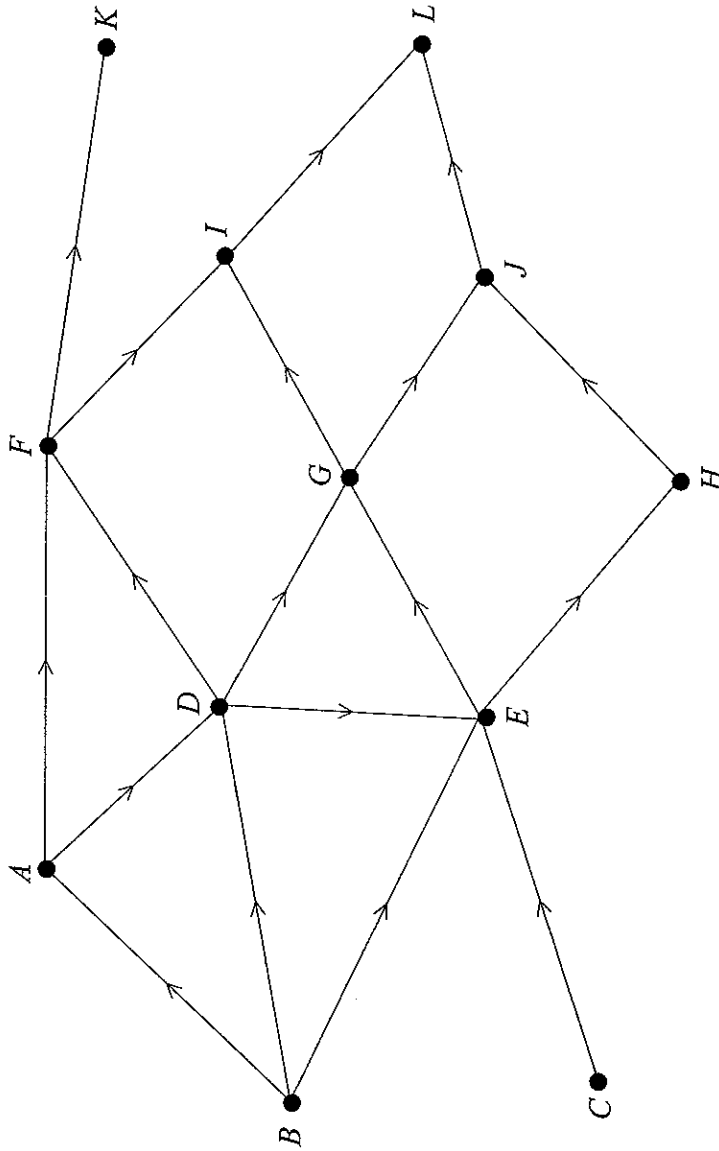

Value of flow _____

(Total 14 marks)



BLANK PAGE



BLANK PAGE



N 2 2 0 9 8 A 0 1 5 1 6

BLANK PAGE

